

Article number: 439500028
 Description: Rota-fix shaft-hub connection F28x55
 Steel
 Note: Self centering. Very high torque

Measures

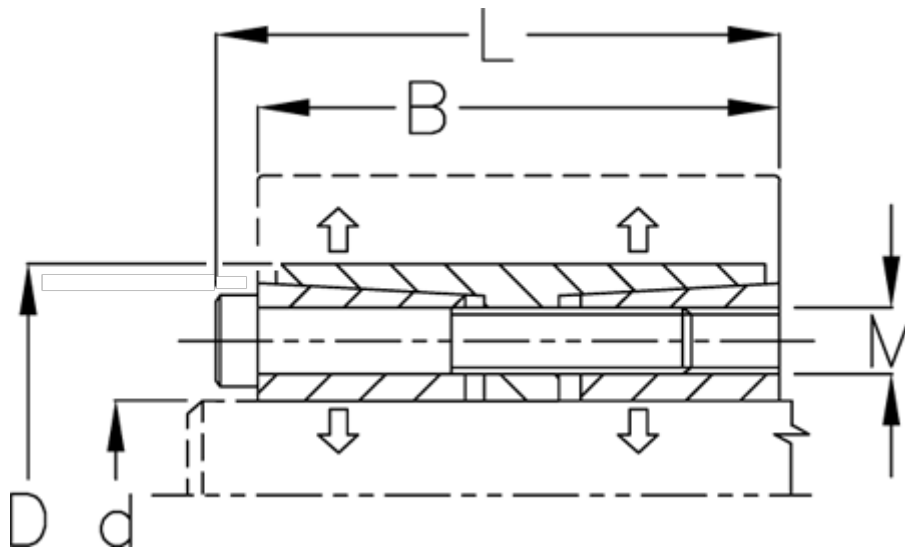

B mm	= 45
d H8 mm	= 28
D mm	= 55
Fit tolerance	= Aksel h8, Nav H8
F kN torque	= 70.0
L mm	= 51
M mm	= M6
P N/mm ² surface pressure on shaft/hub	= 90

Surface roughness	= R? ? 3.2 µm
T N m torque	= 1000
Ts N m bolt tightening torque	= 17.0